

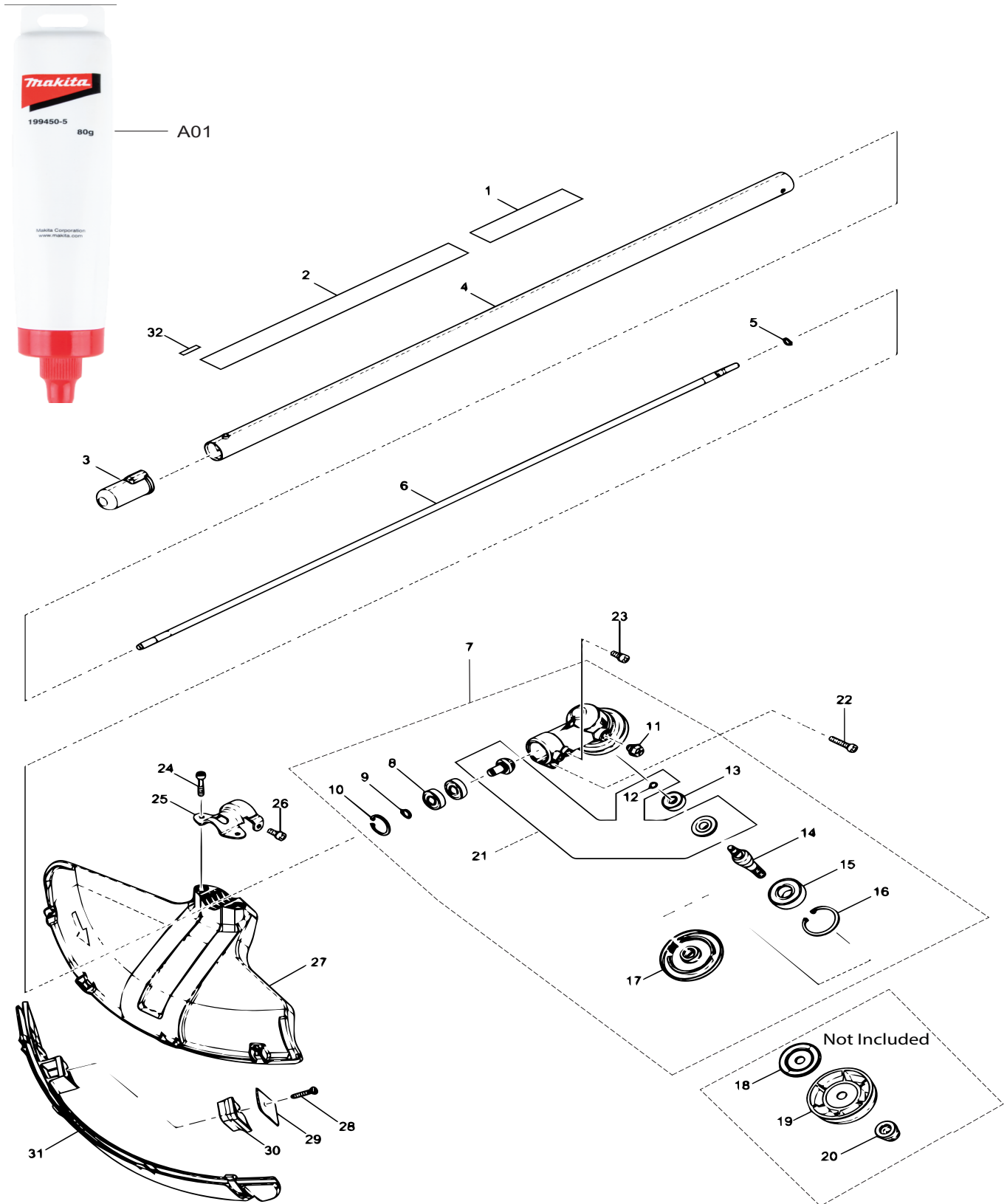

PARTS BREAKDOWN

EM403MP



Products with multiple versions are listed in subsiding order with the newest version on top not indented.

Section	Fig. No.	Part No.	Description	EM403	Tech Bulletin	Notes
1	1	819312-8	MAKITA LOGO LABEL	1		
1	2	819V89-7	CAUTION LABEL	1		
1	3	424434-7	CAP 24	1		
1	4	141010-9	SHAFT PIPE A COMPLETE	1		
1	5	961003-8	RETAINING RING S-7	1		
1	6	326088-5	SHAFT A	1		
1	7	123854-9	GEAR CASE ASSEMBLY	1		INC. 8-11,13-21
1	8	210049-4	BALL BEARING 609ZZ	2		
1	9	257986-1	RETAINING RING (EXT) S-9	1		
1	10	257987-9	RETAINING RING (INT) R-24	1		
1	11	265590-2	+HEX.BOLT M8X10 WITH R	1		
1	12	232350-7	RING SPRING 6	1		
1	13	210025-8	BALL BEARING 627ZZ	1		
1	13	210030-5	BALL BEARING 627ZZ	1		
1	14	326854-0	CUTTER SHAFT	1		
1	15	211228-7	BALL BEARING 6202DDW	1		
1	16	257432-4	RETAINING RING R-35	1		
1	17	144312-2	RECEIVE WASHER COMPLETE	1		
1	18	346660-7	CLAMP WASHER	1		Accessory not included
1	19	457290-0	CUP	1		Accessory not included
1	20	252236-9	HEX. LOCK NUT M10-17	1		Accessory not included
1	21	183J06-4	SPIRAL BEVEL GEAR SET	1		INC. 12
1	22	922242-5	HEX. SOCKET HEAD BOLT	1		
1	23	922216-6	HEX. SOCKET HEAD BOLT	1		
1	24	251513-6	H.S.H.BOLT M5X25	2		
1	25	347107-4	PROTECTOR CLAMP 24	1		
1	26	922216-6	HEX. SOCKET HEAD BOLT 5X14	1		
1	27	457271-4	PROTECTOR U 450	1		
1	28	266553-1	TAPPING SCREW 5X30	1		
1	29	347115-5	CUTTER	1		
1	30	457794-2	CUTTER EXTENSION	1		
1	31	144316-4	PROTECTOR U EXT. 420-450 COMP	1		
1	32	814A82-0	DATE CODE LABEL	1		
1	A01	199450-5	GEAR GREASE	1		